

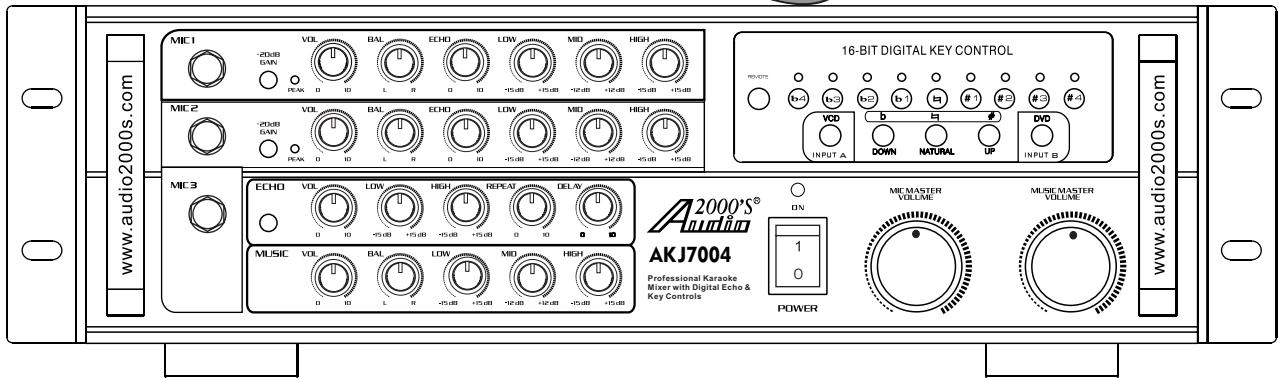

AKJ7004

Professional Karaoke Mixer with Digital Echo & Key Controls

OWNER'S MANUAL

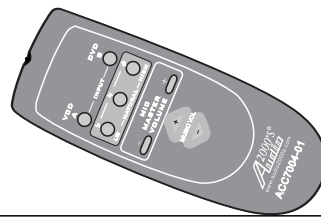

Thank you for purchasing the Audio2000'S® Professional Karaoke Mixer with Digital Echo & Key Controls! To achieve maximum performance from your new unit, please read this manual thoroughly, and retain it for future reference. For more information, please visit our website (www.audio2000s.com).

TABLE CONTENTS :

WARNING AND SAFETY INSTRUCTION.....	1
FEATURES	3
HANDLING PRECAUTIONS	3
BEFORE CONNECTIONS	3
DESCRIPTIONS AND FUNCTIONS	
● FRONT PANEL	4
● REAR PANEL	6
RCA CONNECTIONS	7
SYSTEM CONNECTIONS	8
GENERAL OPERATION	9
REMOTE CONTROL COMMANDER.....	10
SAFETY PRECAUTIONS	11
MAINTENANCE.....	12
TROUBLESHOOTING	12
ETIQUETTE OF SOUND	12
SPECIFICATIONS	13
SERVICE INFORMATION.....	14

IMPORTANT

For your protection, please read these instructions completely, and keep this manual for future reference.

Carefully observe and comply with all warnings, cautions, and instructions placed on the equipment or described in the operations instructions to guard against injury.

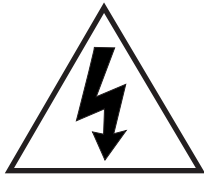

CAUTION
RISK OF ELECTRIC SHOCK
DO NOT OPEN



**CAUTION: TO REDUCE THE RISK OF ELECTRIC SHOCK,
DO NOT REMOVE COVER (OR BACK)
NO USER-SERVICEABLE PARTS INSIDE
REFER SERVICING TO QUALIFIED SERVICE PERSONNEL**

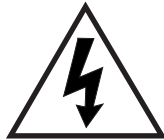

The lightning flash with arrowhead symbol, within an equilateral triangle, is intended to alert the user to the presence of uninsulated "dangerous voltage" within the product's enclosure that may be of sufficient magnitude to constitute a risk of electric shock to persons.



The exclamation point within an equilateral triangle is intended to alert the user to the presence of important operating and maintenance (servicing) instructions in the literature accompanying the appliance.

WARNING

**TO REDUCE THE RISK OF FIRE OR ELECTRIC SHOCK,
DO NOT EXPOSE THIS APPLIANCE TO RAIN OR MOISTURE**

**CAUTION: TO PREVENT ELECTRIC SHOCK, MATCH WIDE
BLADE OF PLUG TO WIDE SLOT, FULLY INSERT.**

**ATTENTION: POUR ÉVITER LES CHOCS ÉLECTRIQUES
INTRODUIRE LA LAME LA PLUS LARGE DE LA FICHE DANS
LA BORNE CORRESPONDANTE DE LA PRISE ET POUSSER
JUSQU'AU FOND.**

SAFETY INSTRUCTIONS

READ BEFORE OPERATING EQUIPMENT

This product was designed and manufactured to meet strict quality and safety standards. There are, however, some installation and operation precautions which you should be particularly aware of.

- 1) Read Instructions--All the safety and operating instructions should be read before the appliance is operated.
- 2) Retain Instructions--The safety and operating instructions should be retained for future reference.
- 3) Heed Warnings--All warnings on the appliance and in the operating instructions should be adhered to.
- 4) Follow Instructions--All operating and use instructions should be followed.
- 5) Water and Moisture--The appliance should not be used near water -- for example, near a bathtub, wash-bowl, kitchen sink, laundry tub, in a wet basement, or near a swimming pool, etc.
- 6) Carts and Stands--The appliance should be used only with a cart or stand that is recommended by the manufacturer.



- 7) An appliance and cart combination should be moved with care. Quick stops, excessive force, and uneven surfaces may cause the appliance and cart combination to overturn.
- 8) Wall or Ceiling Mounting--The appliance should be mounted to a wall or ceiling only as recommended by the manufacturer
- 9) Ventilation--The appliance should be situated so that its location or position does not interfere with its proper ventilation. For example, the appliance should not be situated on a bed, sofa, rug, or similar surface that may block the ventilation openings; or, placed in a built-in installation, such as a bookcase or cabinet that may impede the flow of air through the ventilation openings.
- 10) Heat--The appliance should be situated away from heat sources such as radiators, heat registers, stoves, or other appliances (including amplifiers) that produce heat.

- 11) Power Sources--The appliance should be connected to a power supply only of the type described in the operating instructions or as marked on the appliance.
- 12) Grounding or Polarization--The precautions that should be taken so that the grounding or polarization means of an appliance is not defeated.

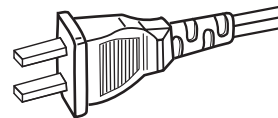

AC POLARIZED PLUG

- 13) Power-Cord Protection--Power-supply cords should be routed so that they are not likely to be walked on or pinched by items placed upon or against them, paying particular attention to cords at plugs, convenience receptacles, and the point where they exit from the appliance.
- 14) Cleaning--The appliance should be cleaned only as recommended by the manufacturer.
- 15) Power Lines--An outdoor antenna should be located away from power lines.
- 16) Nonuse Periods--The power cord of the appliance should be unplugged from the outlet when left unused for a long period of time.
- 17) Object and liquid Entry--Care should be taken so that objects do not fall and liquids are not spilled into the enclosure through openings.
- 18) Damage Requiring Service--The appliance should be serviced by qualified service personnel when;
 - A. The power-supply cord or the plug has been damaged;
 - B. Objects have fallen, or liquid has spilled into the appliance;
 - C. The appliance has been exposed to rain;
 - D. The appliance does not appear to operate normally or exhibits a marked change in performance;
 - E. The appliance has been dropped, or the enclosure damaged.
- 19) Servicing--The user should not attempt to service the appliance beyond that described in the operating instructions. All other servicing should be referred to qualified service personnel.

FEATURES

1. 9-step 16-Bit Digital Key Control
2. Three Unbalanced 1/4" Microphone Inputs
3. Two Switchable RCA A/V Inputs
4. Three RCA Audio Outputs (MIC, REC, LINE)
5. Two RCA Video Inputs (VCD, DVD)
6. Two RCA Video Outputs
7. Stereo Effect Loop for External Sound Effect Units
8. Master Music Volume, Balance and Low/Mid/High Frequency Controls
9. Master Echo Volume, Low/High Frequency, Repeat and Delay Controls
10. Master Microphone Volume Control
11. Individual Microphone -20dB Gain Pad and Signal Peak LED Indicator
12. Individual Microphone Volume, Balance, Echo and Low/Mid/High Frequency Controls
13. Stereo/Mono Echo Selection Button
14. Remote Key Control Input
15. Remote Control
16. AC 115V 60Hz/AC 230V 50Hz Compatible

HANDLING PRECAUTIONS

Do not install the unit in following places:

- In a place which is exposed to direct sunlight or near a source of heat such as a radiator.
- In a place where the heat cannot escape due to poor ventilation, or where it is very humid or dusty.
- In an unstable place with excessive vibrations or sloping.
- In a place which may be exposed to rain, such as near a window.
- In a place which may be exposed to soot, vapor or heat, such as near a cooking stove.

BEFORE CONNECTIONS

Connection precautions

- Be sure to switch off the powers of the related equipment before making any connection.
- The "White" input/output jacks of the amplifier are designed for the Left channel, while the "Red" jacks are for the Right channel. Be sure to connect the cords without mistaking the correspondences of the Left and Right channels.
- Insert the plugs of the connection cords securely into the jacks. If the connection is incomplete, sound may not be produced or noise may be generated.
- When unplugging the power cord from the power outlet, be sure to grasp the plastic molding of the plug and pull.

Power consumption of AC power outlets

- Be careful that the total power consumption does not exceed the wattage marked on the rear panel. Do not connect other appliances than the system components to the power outlets of this unit.
- Do not connect a TV set to this unit, even if the power consumption value marked on a TV set is below the permissible limit of this unit. A larger current than the permissible value may flow when the TV power is turned on.

DESCRIPTIONS AND FUNCTIONS

[FRONT PANEL]

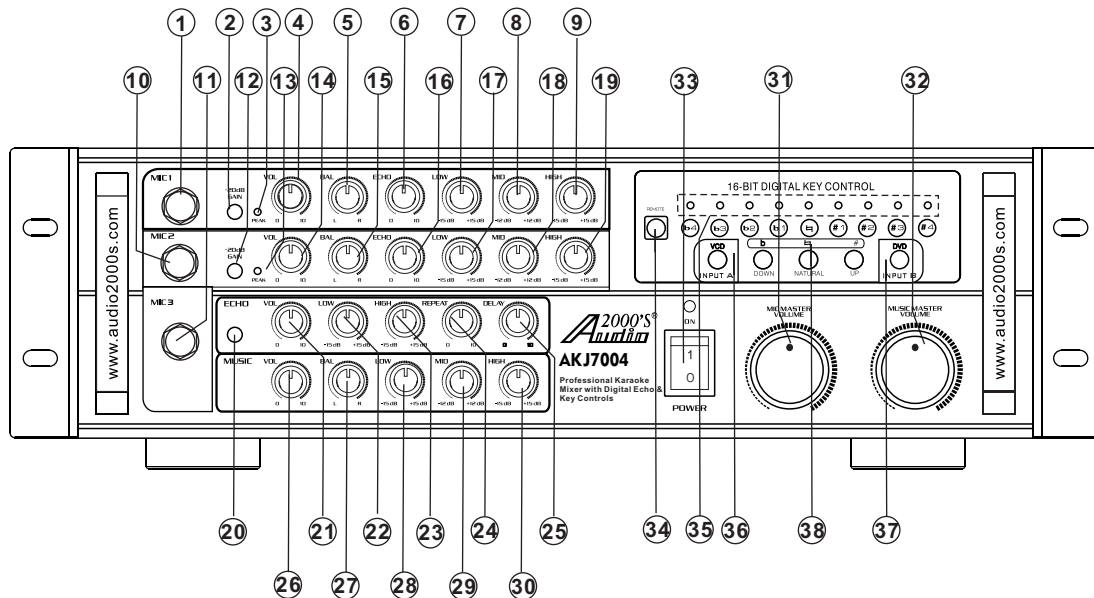

- 1. MIC1** - This is the microphone 1 unbalanced 1/4" input jack.
- 2. -20dB GAIN** - Press this -20dB GAIN button to lower the MIC1 microphone audio level by 20 dB.
- 3. PEAK** - This PEAK LED indicator is used to indicate that the MIC1 input audio level exceeds a preset limit.
- 4. VOL** - This VOL control knob is used to adjust the MIC1 audio level. Turn this knob clockwise to raise the MIC1 audio level or turn this knob counter-clockwise to lower the MIC1 audio level.
- 5. BAL** - This BAL control knob is used to allocate the portion of the MIC1 audio level to the left channel and the right channel. When this knob is turned clockwise, the MIC1 audio level allocated to the right channel is raised while the MIC1 audio level allocated to the left channel is lowered. When this knob is turned counter-clockwise, the MIC1 audio level allocated to the left channel is raised while the MIC1 audio level allocated to the right channel is lowered.
- 6. ECHO** - This ECHO control knob is used to control the MIC1 audio echo level (echo volume).
- 7. LOW** - This LOW control knob is used to control the MIC1 audio low frequency band centered at around 150 Hz.
- 8. MID** - This MID control knob is used to control the MIC1 audio mid frequency band centered at around 1K Hz.
- 9. HIGH** - This HIGH control knob is used to control the MIC1 audio high frequency band centered at around 6.5K Hz.
- 10. MIC2** - This is the microphone 2 unbalanced 1/4" input jack.
- 11. MIC3** - This is the microphone 3 unbalanced 1/4" input jack. The MIC2 and MIC3 input jacks share the same control channel.
- 12. -20dB GAIN** - Press this -20dB GAIN button to lower the MIC2 and MIC3 microphone audio levels by 20 dB.
- 13. PEAK** - This PEAK LED indicator is used to indicate that the MIC2 and MIC3 input audio levels exceed a preset limit.
- 14. VOL** - This VOL control knob is used to adjust the MIC2 and MIC3 audio levels. Turn this knob clockwise to raise the MIC2 and MIC3 audio levels or turn this knob counter-clockwise to lower the MIC2 and MIC3 audio levels.
- 15. BAL** - This BAL control knob is used to allocate the portion of the MIC2 and MIC3 audio levels to the left channel and the right channel. When this knob is turned clockwise, the MIC2 and MIC3 audio levels allocated to the right channel are raised while the MIC2 and MIC3 audio levels allocated to the left channel are lowered. When this knob is turned counter-clockwise, the MIC2 and MIC3 audio levels allocated to the left channel are raised while the MIC2 and MIC3 audio levels allocated to the right channel are lowered.

DESCRIPTIONS AND FUNCTIONS

[FRONT PANEL]

- 16. ECHO** - This ECHO control knob is used to control the MIC2 and MIC3 audio echo levels (echo volumes).
- 17. LOW** - This LOW control knob is used to control the MIC2 and MIC3 audio low frequency band centered at around 150 Hz.
- 18. MID** - This MID control knob is used to control the MIC2 and MIC3 audio mid frequency band centered at around 1K Hz.
- 19. HIGH** - This HIGH control knob is used to control the MIC2 and MIC3 audio high frequency band centered at around 6.5K Hz.
- 20. ST/MO (Stereo/Mono)** - Depress this button to enter the stereo echo output mode. Press to lift this button again to enter the mono echo output mode.
- 21. ECHO VOL** - This is the echo volume control knob.
- 22. LOW** - This LOW control knob is used to control the echo low frequency band.
- 23. HIGH** - This HIGH control knob is used to control the echo high frequency band.
- 24. REPEAT** - This REPEAT control knob is used to adjust how many times the echo sound is to be repeated.
- 25. DELAY** - This DELAY control knob is used to adjust the time duration between each echo sound.
- 26. MUSIC VOL** - This is the music volume control knob.
- 27. BAL** - This BAL control knob is used to allocate the portion of the music audio level to the left channel and the right channel. When this knob is turned clockwise, the music audio level allocated to the right channel is raised while the music audio level allocated to the left channel is lowered. When this knob is turned counter-clockwise, the music audio level allocated to the left channel is raised while the music audio level allocated to the right channel is lowered.
- 28. LOW** - This LOW control knob is used to control the music audio low frequency band centered at around 150 Hz.
- 29. MID** - This MID control knob is used to control the music audio mid frequency band centered at around 1K Hz.
- 30. HIGH** - This HIGH control knob is used to control the music audio high frequency band centered at around 6.5K Hz.
- 31. MIC MASTER VOLUME** - This is the microphone master volume control knob. This knob can be controlled by the remote control unit.
- 32. MUSIC MASTER VOLUME** - This is the music master volume control knob. This knob can be controlled by the remote control unit.
- 33. POWER** - Press this switch upward (to 1) to turn on the power. Press this switch downward (to 0) to turn off the power.
- 34. REMOTE** - The infrared control signal from the remote control unit is to be received through this sensor.
- 35. Key Control LED Indicators (b4 - #4)** - These key control LED indicators are used to show which key (from b4 to #4) is being applied to the music tone.
- 36. A INPUT** - Press this button to select the music input A (VCD).
- 37. B INPUT** - Press this button to select the music input B (DVD).
- 38. Key Control Buttons (b, ♭, #)**
 - b: Lowers the music key one step (each step is $\frac{1}{4}$ note) each time this button is pressed
 - ♭: Press this button to reset the music key to its natural key.
 - #: Raises the music key one step (each step is $\frac{1}{4}$ note) each time this button is pressed

NOTE: The key will stay until it is changed further.

DESCRIPTIONS AND FUNCTIONS

[REAR PANEL]

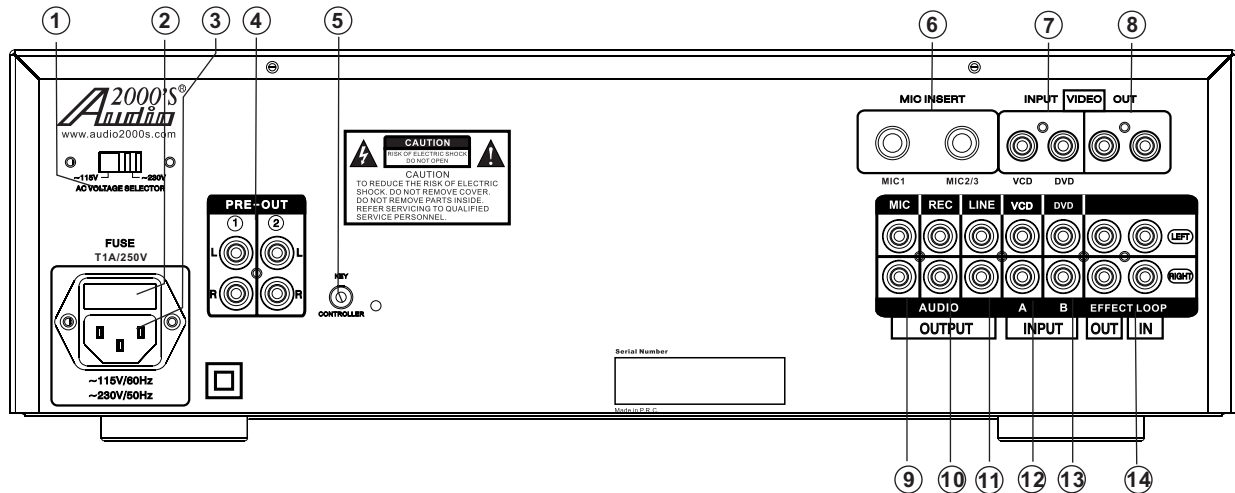

- 1. AC VOLTAGE SELECTOR** - Check to make sure that the AC Voltage Selector switch is set to the proper voltage for your area (120V/60Hz for the North America area) before plugging in the AC power cord to the AC power outlet.

CAUTION: Unplug the AC power cord from the AC power outlet before resetting the AC voltage selector switch.
- 2. FUSE** - Please turn off the AC power and unplug the AC power cord before replacing the fuse. (ONLY replacing with the same type and rating of new fuse. When the AC VOLTAGE SELECTOR is set to either 115V or 230V, the new fuse should have the rating of **T1A/250V**.)
- 3. ~115V/60Hz ~230V/50Hz AC Power Input Terminal**
- 4. PRE OUT** - The pre-amplifier audio output (PRE-OUT) can be connected to an external power amplifier if needed.
- 5. KEY CONTROLLER** - This KEY CONTROLLER 3.5mm input jack is to be connected to some special equipment, such as a key control microphone.
- 6. MIC INSERT** - These are the TRS ¼" microphone effect inserts. The tip of the insert is used as the audio signal output (to the sound effect equipment), the ring of the insert is used as the audio signal input (from the sound effect equipment), and the sleeve is used as the ground. The MIC1 is the microphone effect insert for the MIC1 input. The MIC2/3 is the microphone effect insert for the MIC2 and MIC3 inputs.
- 7. VIDEO INPUT** - There are two video inputs, VCD and DVD.
- 8. VIDEO OUT** - There are two independent video output jacks (each with its own driver).
- 9. MIC AUDIO OUTPUT** - This audio output comprises the microphone audio signal only.
- 10. REC AUDIO OUTPUT** - This audio output is for the recording purpose and comprises a fixed predetermined audio level.
- 11. LINE AUDIO OUTPUT** - This is a line audio output with the audio level controllable by the microphone and music volume controls.
- 12. INPUT A (VCD/CD)**
- 13. INPUT B (DVD)**
- 14. EFFECT LOOP** - The EFFECT LOOP allows the AKJ7004 user to add any sound effector, such as an equalizer, as a part of the music loop in the AKJ7004 unit. If an external sound effect is not used, check to make sure that two U-shaped connectors are connected from the OUT jacks to the IN jacks. The top U-shaped connector is to be connected from the white OUT jack to the white IN jack. The bottom U-shaped connector is to be connected from the red OUT jack to the red IN jack. If a sound effector is to be placed in between the OUT jacks and the IN jacks, the U-shaped connectors need to be removed from the unit and make sure that these two U-shaped connectors are taped to the bottom of the unit for future use. The OUT jacks are to be connected to the input ports of the sound effector while the IN jacks are to be connected to the output ports of the sound effector.

RCA CONNECTIONS

Connecting the RCA Cables

When connecting the RCA cables to the RCA jacks, be sure to insert the red RCA plug into the red RCA jack and the white or black RCA plug into the white RCA jack.

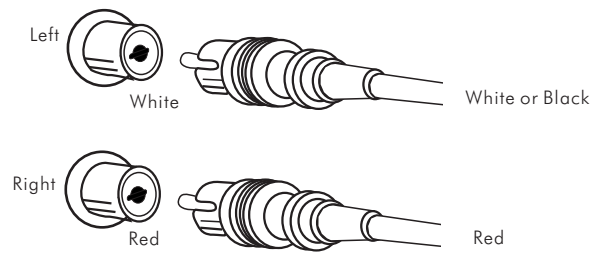

SYSTEM CONNECTIONS

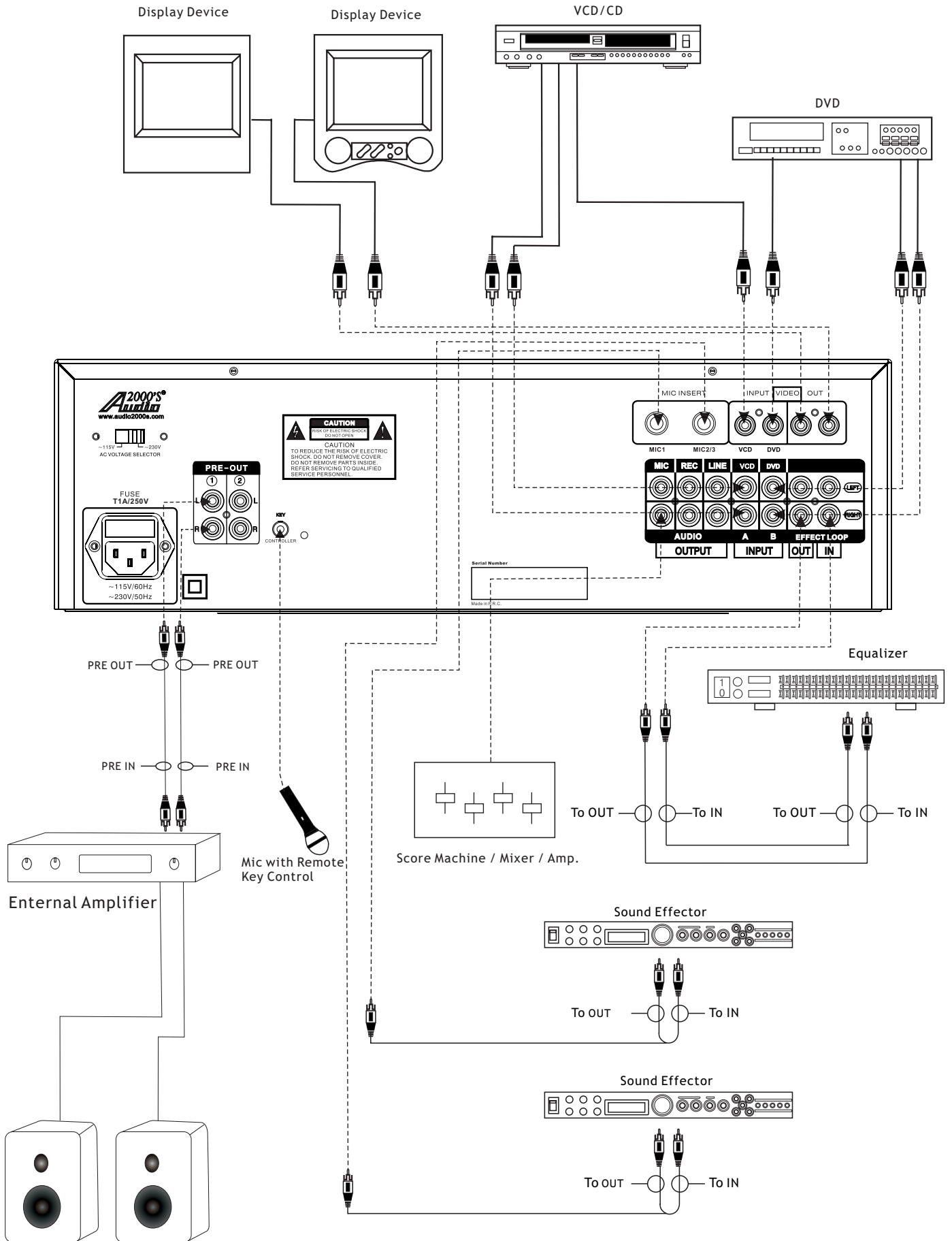

GENERAL OPERATION

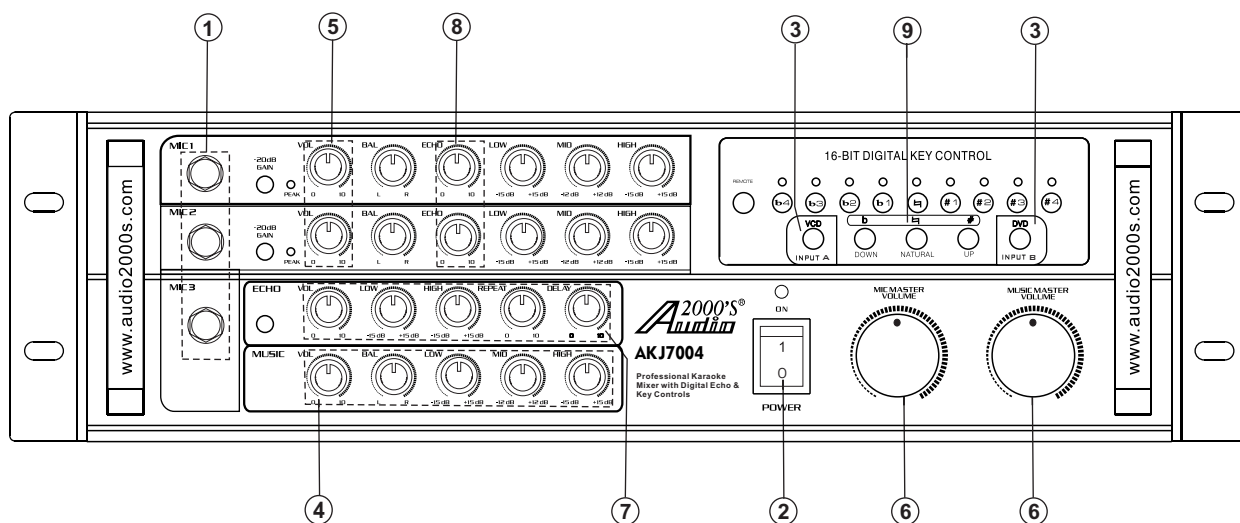

1. Connect a desired number of microphones to the microphone inputs on the AKJ7004.
2. Turn on the power of the AKJ7004 and other needed components.
3. Select a karaoke music source.
4. Adjust the music volume, balance, and tone.
5. Adjust each microphone volume by adjusting the individual microphone VOLUME control knobs.
6. Adjust the desired relative volumes between microphones and music by adjusting the MIC MASTER VOLUME and MUSIC MASTER VOLUME control knobs
7. Adjust the echo volume, tone, repeat, and delay.
8. Adjust the individual microphone echo volume by adjusting the echo volume control knobs in the MIC1 and MIC2/3 channels.
9. Press the KEY CONTROL button to set the desired key.

Notes for Proper Use of a Microphone

- Hold a microphone to have the top of its windscreen 1 to 2 inches away from your mouth.
- To get the best pickup result, point the microphone toward your mouth.
- To ensure a clear vocal output, do not block the lower part of the microphone windscreen. Blocking the lower part of the microphone windscreen will disturb the proper voice reproduction with an unclear bass which tends to cause the feedback (howling) results.

REMOTE CONTROL COMMANDER

DESCRIPTIONS AND FUNCTIONS

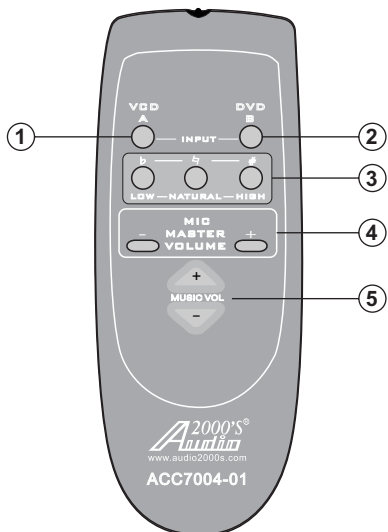

- 1. INPUT A(VCD)** - Press this button to select the music source from input A.
- 2. INPUT B(DVD)** - Press this button to select the music source from input B.
- 3. KEY CONTROL BUTTONS (b, h, #)**
 - b: Lowers the music key one step (each step is 1/4 note) each time this button is pressed
 - h: Press this button to reset the music key to its natural key.
 - #: Raises the music key one step (each step is 1/4 note) each time this button is pressed
- NOTE:** The key will stay until it is changed further.
- 4. MIC MASTER VOLUME** - These are the microphone master volume control buttons. Press the "+" button to raise the microphone master volume. Press the "-" button to lower the microphone master volume.
- 5. MUSIC MASTER VOLUME** - These are the music master volume control buttons. Press the "+" button to raise the music master volume. Press the "-" button to lower the music master volume.

1. Operating range

- The operating range of the remote control commander is within a distance of about 16ft from the remote control sensor on the amplifier.
- Do not point the transmitter on the front edge of the remote control commander to any other direction than the remote control sensor of the amplifier or leave an obstacle between the remote control commander and the amplifier. Doing these may make remote control impossible.

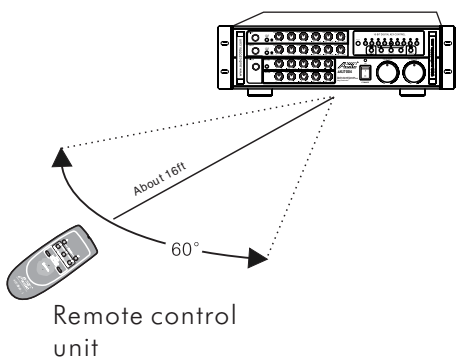

3. Battery handling precautions

- Battery may explode or its fluid may leak if the batteries are handled in a wrong way. Take care of the following when handling the batteries.
- Insert batteries with correct positive (+) and negative(-) polarities as indicated on the set.
 - Even batteries with the same shape sometimes have different voltages. Do not mix batteries with different types together.
 - Do not use new and old batteries together. When replacing batteries, be sure to replace both of them.
 - Do not heat, open or short-circuit a battery or dispose of it in fire.
 - Some batteries are rechargeable and some are not. Check the indication on each battery well.

2. Loading batteries

- The battery life is about 1 year under normal use, but it is recommended to replace the batteries when their power seems to be weak.
- This remote control commander accepts two "AAA" batteries.
- Remove the batteries if the remote control commander is not to be used for a long period of time.

1. Push the tab and remove the battery cover.
2. Insert batteries with correct positive(+) and negative(-) polarities. "AAA" batteries X 2
3. Push the cover close until it clicks.

SAFETY PRECAUTIONS

In case of abnormality

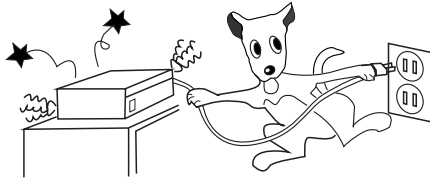

In case an abnormal noise or smell is generated from the unit during use, immediately switch the power off, unplug the power cord from the power outlet, and consult your dealer or an authorized service center for a check-up.

Do not open the unit



High-voltage components are used inside the unit. Do not open the cabinet to check or modify the unit, for this will cause the danger of electric shock. Performance degradation or malfunction due to the user modification will not be covered by the warranty.

Do not exceed the maximum power capacity



The components equipped with the rear panel AC OUTLETS accept the connection of other stereo system components. However, do not connect components the total power consumption of which exceed the power capacity marked on the panel, for this may cause malfunction or fire hazard. Also note that components in which large current flows when the power is switched on, such as a TV, cannot be connected to such an AC outlet unless it has been designed to accept the connection of a TV set.

Keep away from water and foreign objects

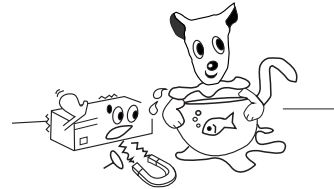

Do not insert or drop metallic objects, such as a hairpin, nail and coin, or flammable objects, such as paper and matches, through the ventilation holes or other openings on the unit, for this will cause malfunction or hazard of fire and electric shock. In case water or a foreign object enters inside the unit, consult an authorized service center or your dealer for a check-up.

Do not damage the power cord

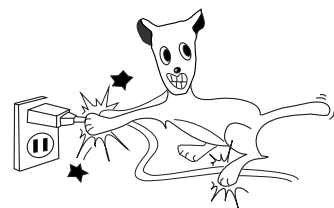

Hold the power plug when plugging or unplugging the power cord. Do not pull the cord or touch it with wet hands, for this may cause short-circuit or electric hazard. Do not leave the power cord under this unit, or under furniture, or between objects. Also do not tie the power cord with another cord, make a knot on the power cord, or leave it in a place where people walk frequently.

When the unit is not to be used for a long period

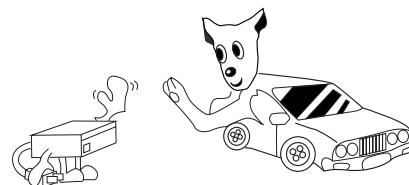

When you will be away from home for a long period of time, for example before going on a trip, set the power switch to off and unplug the power plug from the power outlet for safety. This will prevent fire hazard due to unexpected accidents with the unit.

TROUBLESHOOTING

MAINTENANCE

When the set gets dirty, wipe with a soft, dry cloth. If the set is extremely dirty, soak a soft cloth in a 5 to 6% solution of dishwashing detergent to water, wring it tightly, wipe the dirt away, and finally wipe the set with a dry cloth.

Never use alcohol, thinner, benzene, insecticide or other volatile agents, as they may damage the surface paint or gloss of the set.

Also do not wipe the set with a chemical cloth or leave it on the set for a long period, as the surface finish may be damaged or the paint may be stripped off.

TROUBLESHOOTING

Should problems occur, they are, in many cases, due to simple operation mistakes or the like. On the basis of the following checks, you will be able to rectify a number of problems yourself without difficulty.

If the problem cannot be remedied after the following checks, please consult your dealer.

PROBLEM	POSSIBLE CAUSES	SOLUTIONS
No power	Power is off.	Turn on the mixer.
	AC power cord is unplugged.	Plug the AC power cord to an AC power outlet (120V).
	The fuse inside the transformer is open.	Send the mixer to an authorized service center.
One side no sound	One bad RCA cable or one poor RCA contact.	Make sure that all RCA cables are not damaged and all RCA contact points are proper.
	One U-shaped connector is not inserted into the music effect jacks or one U-shaped connector is not properly inserted.	Make sure all the U-shaped connectors are properly inserted.
Distorted sound	The electrical signal from the output of the player to the mixer is over the limit of the input of the mixer.	Turn down the master volume control of the player and turn up the volume control of the mixer to maintain the same sound level.
	Incorrect AC Voltage (The AC power cord is plugged to a 240V outlet or to an unstable 120V outlet).	Make sure the AC power cord is plugged to an AC power outlet with a correct and stable AC voltage.
No sound	Incorrect input selection.	Make sure the input source selection button is set correctly.
	Music volume control knob is turned all the way down (zero sound output).	Turn the music volume knob to a position that the sound level is desired.
	Both U-shaped connectors are not inserted into the music effect jacks or not properly inserted.	Make sure all the U-shaped connectors are properly inserted.
	Bad cable or poor contact.	Make sure that all cables are not damaged and all contact points are proper.
No microphone sound	The microphone cable is not plugged into the microphone input jack properly.	Make sure the microphone cable is plugged into the microphone jack properly.
	The switch on the microphone is set to "OFF".	Set the switch on the microphone to "ON".
	The corresponding INDIVIDUAL MIC VOLUME control or the MASTER MIC VOLUME control is in the minimum position.	Adjust the volume control.
	A condenser microphone is used.	Change the condenser microphone to a dynamic microphone or a condenser microphone accepting battery power.
Humming noise	Grounding problems between two adjacent equipments.	Try to use an isolator to remove the grounding problems.

ETIQUETTE OF SOUND

The karaoke performance you enjoy may be disturbing noise to others. When performing karaoke, be sure to be considerate of your neighbors.

The volume of karaoke is at your command. Remember that even small sounds transmit very well in the quiet night. Be specially careful in karaoke performance at night. It is recommended to close the windows to avoid sound leakages to the neighbors. Avoid noise pollution to protect the comfortable living environment of those around you.

SPECIFICATIONS

Mixer

Total Harmonic Distortion 0.03%

Input Jacks(Sensitivity/Impedance)

MIC(1,2/3) <10mV

DVD,VCD..... 350mV/23k Ω

Output Jacked (Output level/Output Impedance)

PRE Out.....1V/330 Ω

Frequency Responses

MIC Frequency Sound..... 100Hz to 25kHz

MUSIC 10Hz to 20kHz, +3/-3dB

Tone Control Characteristics

Music BASS +15/-15dB(100Hz)

MID +12/-12dB(1KHz)

TREBLE +15/-15dB(6.3KHz)

Microphone BASS +15/-15dB(100Hz)

MID +15/-15dB(2KHz)

TREBLE +15/-15dB(10kHz)

Key Control Range 9 steps

Video Input Jacks

(Sensitivity/Input Impedance) 1Vp-p/75 Ω

Video Output Jacks

(Output level/Output Impedance) 1Vp-p/75 Ω

Effect Loop Jacks

(Output level/Input Sensitivity).....500mVp-p/4.7k Ω

MIC Output..... 1Vp-p/4.7k Ω

REC Output.....1Vp-p/4.7k Ω

LINE Output.....2Vp-p/4.7k Ω

Power Supply, etc.

Supply Voltage AC 115V/230V 60Hz/50Hz

Power Consumption30W

Dimensions(W X H X D).....16.5" X 5.4" X 14.6"

Weight.....8.82 lbs

Accessories

Remote Control Unit 1

Rack Mount..... 2

Power Cord..... 1

Owner's Manual 1

Warranty Card..... 1

Dimensions

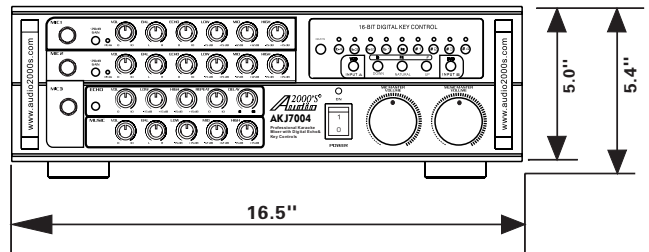
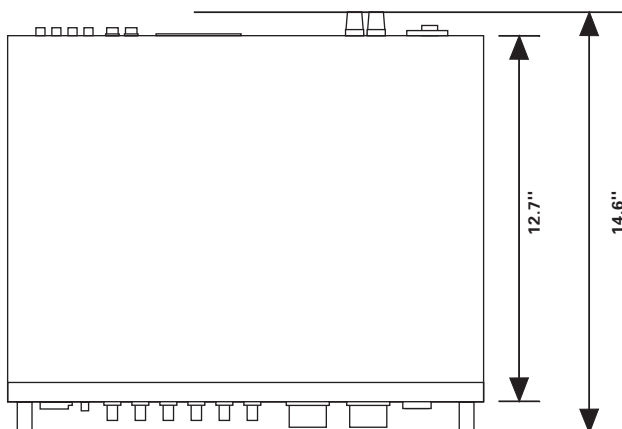

SERVICE INFORMATION

SHIPPING DAMAGE

If the shipping carton is found to be damaged, notify the delivery company immediately. Save the damaged carton as evidence for the delivery company to inspect. It is the responsibility of the consignee to file a claim with the delivery company for any damaged that occurs during shipping. In the case that the shipping carton is in good condition but the unit is damaged or defective, call **Audio2000'S®** at 805-523-2759.

FACTORY SERVICE

If the equipment needs factory service, call **Audio2000'S®** at 805-523-2759 for a Return Authorization number (RA number) and the address of the authorized service representatives. Insure and ship the product, prepaid, in its original carton along with proof of purchase in the form of a bill of sale or receipted invoice to the above address. Please clearly write the RA number on the shipping carton. Also enclose a note describing the problem along with any other helpful information such as where and how the unit was used.

LIMITED WARRANTY

H&F Technologies, Incorporated (H&F) hereby warrants that **Audio2000'S®** products will be free from defects in material and workmanship for a period of 1 (one) year from date of purchase. At its option, H&F will repair or replace the defective product and promptly return it to you.

The Limited Warranty will not cover any item that has been, in H&F's estimation, subject to alteration, misuse, neglect, accident or improper installation. In addition, any service not performed by H&F or an authorized service center will terminate terms of this warranty. Normal wear and tear of this product will not be covered by this or any implied warranty.

No liability will be accepted for damages/loss directly caused from the use of this product.

H&F's liability shall be limited to the repair/replacement of this product if found to be defective.

© 2010 H & F Technologies, Incorporated (website: www.audio2000s.com)