

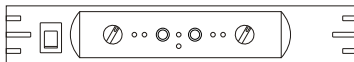

**PROFESSIONAL DUAL-CHANNEL
UHF WIRELESS SYSTEM WITH 16
ADJUSTABLE FREQUENCIES**

AWM6525U OWNER'S MANUAL

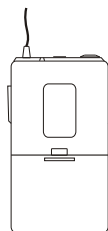
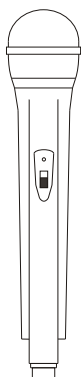

Thank you for purchasing the **Audio2000's**® professional dual-channel UHF wireless system with 16 adjustable frequencies! For the best results and the utmost satisfaction from your new unit, please read this manual thoroughly, and retain it for future reference.

TABLE OF CONTENTS

Warning	1
Precautions	1
Package Contents	2
Quick Setup	3
Features	6
System Configurations	7
System Functions	7
Operation - AWR6525U	7
Operation - AWX6525U	9
Operation Notes	11
Specifications	12
Troubleshooting	13
Service Information	15

WARNING

To prevent fire or shock hazard, do not expose the unit to rain or moisture.

Dangerously high voltages are present inside the unit. Do not open the cabinet. Refer servicing to qualified personnel only.

PRECAUTIONS

On Safety

- * Operate only on designated AC power supply (120V AC in North America).
- * Should any liquid or solid object fall into the cabinet, unplug the unit and have it checked by qualified personnel before operating it any further.

- * Unplug the unit from the wall outlet or set the Master switch to OFF if it is not to be used for several days.
- * To disconnect the cord, pull it out by the plug. Never pull the cord itself.

On Installation

- * Allow adequate air circulation to prevent internal heat build-up. Do not place the unit on surfaces (rugs, blankets, etc.) or near materials (curtains, draperies) that may block the ventilation holes.
- * Do not install the unit in a location near heat sources such as radiators or air ducts, or in a place subject to direct sunlight, excessive dust, mechanical vibration or shock.

On Repackaging

Do not throw away the carton and packing materials. They make an ideal container in which to transport the unit. When shipping the unit to another location, repack it as it was originally packed at the factory.

PACKAGE CONTENTS

Items	Quantities
AWR6525U Receiver	1
Wireless Transmitters (AWX6525's)	2
Two Handhelds	
or	
Two Body Packs	
or	
One Handheld + One Body Pack	
AC/DC Adaptor	1
Antennas	2
¼" to ¼" Cable	1
AA Batteries (Two for Each Transmitter)	4
Owner's Manual	1

QUICK SETUP

A. Remove packing material

B. Install the AWR6525U receiver

1. Place the AWR6525U receiver at a location at least 3.5 feet (1 meter) away from the ground and all the walls. Also, keep the AWR6525U receiver away from any electro-magnetic noise sources as far as possible.
2. Mount both the antennas onto the left and right TNC antenna jacks. Make sure that any of the antennas is not enclosed in a large metal body.
3. Plug the supplied AC/DC adaptor 12VDC output connector to the AWR6525U receiver's DC input, and then plug the AC input of the adaptor to a 120V AC outlet (North America).
4. Connect the outputs of the AWR6525U receiver to microphone inputs of a mixer or a sound system. In order to do so, (1) you could use the supplied microphone cable (a cable with $\frac{1}{4}$ " connectors on both ends) to connect from the unbalanced output (an $\frac{1}{4}$ " jack) to an $\frac{1}{4}$ " microphone input on a mixer or a sound system; or (2) you could get two balanced microphone cables (cables with a male XLR connector at one end and a female XLR connector on the other end; not included in the package) to connect from both the balanced outputs (male XLR jacks) to two balanced microphone inputs (female XLR jacks) on a mixer or a sound system.
5. Turn both audio level adjustment knobs all the way to the minimal audio position. Press the power On/Off switch to turn on the AWR6525U receiver. After the power of the AWR6525U receiver is turned on, the power LED indicator will be turned on. (**Note:** The audio level adjustment knobs will be adjusted to its optimal position after the transmitters are turned on as discussed in the following section.)

C. Set up the transmitters

(a) Set up the handheld transmitter

1. Open the battery cover of the handheld transmitter by sliding the battery cover out.
2. Place two 1.5V AA batteries into the battery housing with the battery polarity orientation as indicated.
3. Place the battery cover back on the handheld transmitter by sliding the battery cover back in.
4. Turn on the power of the handheld transmitter.

(b) Set up the body-pack transmitter

1. Open the battery cover of the body-pack transmitter by pushing the latch button (refer to numerals 31 & 32 on pages 10 and 11) inwards (There is a concaved opening and the latch button is at the lower side of the opening) and flipping open the battery cover.
2. Place two 1.5V AA batteries into the battery compartment with the battery polarity orientations as indicated.
3. Plug the supplied headset or lavalier microphone into the microphone input (a mini XLR jack) on the body-pack transmitter. When the lavalier microphone is used, the AUDIO INPUT ATTENUATION SWITCH (refer to numeral 27 on pages 10 and 11) needs to be set to the 0dB position. When the headset microphone is used, the AUDIO INPUT ATTENUATION SWITCH needs to be set to the -10dB position.
4. Flip the cover down in the direction toward the latch button to close the battery cover.
5. Turn on the power of the body-pack transmitter. The green LED indicator will be turned on.

D. Setting up the AWM6525U system

1. The best wireless reception can be achieved by selecting the same DIP switch setup to both channels on the AWR6525U receiver (Selections 0 through 15; Totally 16 selections) as follows:

(NOTE: 0 = DIP Switch Down; 1 = DIP Switch Up)

Selection Number	Channel A DIP Switches	Channel B DIP Switches	Selection Number	Channel A DIP Switches	Channel B DIP Switches
0			8		
1			9		
2			10		
3			11		
4			12		
5			13		
6			14		
7			15		

2. If the transmitters need to have their frequencies adjusted to match to the receiver frequencies, utilize the infrared signal windows as follows:

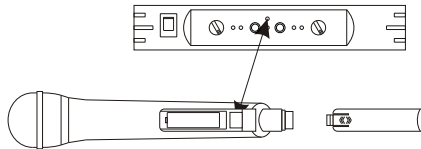

Following the previous sections to open the battery covers of the transmitters (either handheld or body-pack). Keep both transmitters' power on. Press the Channel A Sync button (refer to numeral 5 on pages 7 and 8) and then align the INFRARED SIGNAL RECEIVING WINDOW (refer to numeral 20 on page 9 for handheld transmitter and numeral 26 on page 10 for body-pack transmitter) to the IR Window (refer to numeral 6 on page 8) of the AWR6525U receiver, the above transmitter will be synchronized to the Channel A frequency and the Channel A RF LED light (Green, refer to numeral 3 on page 8) will be turned on to indicate that the above transmitter's signal has been received by the receiver. Press the Channel B Sync button and then align the INFRARED SIGNAL RECEIVING WINDOW of the second transmitter to the IR Window of the AWR6525U receiver, the above transmitter will be synchronized to the Channel B frequency and the Channel B RF LED light (Green) will be turned on to indicate that the above transmitter's signal has been received by the receiver.

3. Adjust the volume control knobs on the AWR6525U to the maximum position and adjust the mixer or the sound system, which is connected to the AWR6525U microphone outputs, to have an optimal sound level. If the sound seems to be abnormal, it may be caused by the overdriven inputs of the mixer or the sound system. Adjust the volume control knobs on the AWR6525U to a lower level until the abnormal sound quality is removed. The AWM6525U is now ready.

4. If more than one AWM6525U are to be used, the frequencies of the AWM6525U systems other than the first one need to be adjusted to be different from one another. First, refer to the DIP Selection Diagram on the top portion of page 5 to select the DIP switch selection number that is different from the other AWR6525U receivers to be used at the same time. (For instance, if there are three AWR6525U receivers to be used at the same time and the frequencies of first two receivers have been selected to be Selection 0 and Selection 9 from the DIP Selection Diagram, the third AWR6526U receiver can select any DIP switch selection numbers other than Selection 0 and Selection 9.) Then, refer to step one of this section for the frequency transmitters' synchronization details.

AWM6525U SYSTEM

FEATURES

1. UHF Band Frequencies
2. Agile Frequencies with PLL (Phase-Lock Loop) 16 Adjustable Frequencies
3. Including Two Wireless Transmitters (Comprising Combinations of Handheld Microphones, Lavalier Microphones, Headset Microphones and or the Guitar transmitters)
4. Two Independent Balanced XLR outputs and One Mixed Unbalanced ¼" Output
5. Microcontroller (CPU) Controlled
6. Automatic Synchronizing the Receiver and Transmitter Frequency through Infrared Signal
7. Two Independent Volume Control Knobs (One for Each Channel)
8. Integrated Antenna for Effective RF Output and High Transmission Quality
9. One Power Red LED indicator, Two AF Red LED indicators, and Two RF Green LED Indicators
10. Rugged Mini Receiver Chassis
11. Operating Range up to 100ft
12. 12VDC Power Supply

SYSTEM CONFIGURATIONS

- AWM6525U - Comprising an AWR6525U receiver and two AWX6525U wireless handheld microphones
- AWM6525UF - Comprising an AWR6525U receiver and one AWX6525UH wireless headset microphone and one AWX6525UM wireless lavalier microphone
- AWM6525UG - Comprising an AWR6525U receiver and two AWX6525UG wireless guitar transmitters
- AWM6525UH - Comprising an AWR6525U receiver and two AWX6525UH wireless headset microphones
- AWM6525UL - Comprising an AWR6525U receiver and one AWX6525U wireless handheld microphone and one AWX6525UM wireless lavalier microphone
- AWM6525UM - Comprising an AWR6525U receiver and two AWX6525UM wireless lavalier microphones
- AWM6525UN - Comprising an AWR6525U receiver and one AWX6525UM wireless lavalier microphone and one AWX6525UG wireless guitar transmitter
- AWM6525UQ - Comprising an AWR6525U receiver and one AWX6525U wireless handheld microphone and one AWX6525UG wireless guitar transmitter
- AWM6525UR - Comprising an AWR6525U receiver and one AWX6525UH wireless headset microphone and one AWX6525UG wireless guitar transmitter
- AWM6525UX - Comprising an AWR6525U receiver and one AWX6525U wireless handheld microphone and one AWX6525UH wireless headset microphone

SYSTEM FUNCTIONS

AWR6525U RECEIVER FRONT PANEL

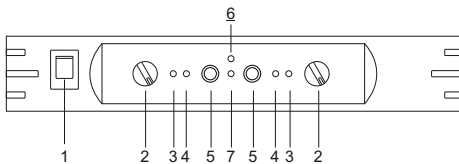

1. POWER ON/OFF SWITCH

2. AUDIO LEVEL ADJUSTMENT KNOBS --- There are two audio level adjustment knobs, one for each channel. These two knobs are used to raise or lower the audio levels.

3. RADIO FREQUENCY (RF) SIGNAL INDICATORS (Green) -- These RF indicators are used to indicate the wireless signals frequency being received from the transmitters.

4. AUDIO FREQUENCY (AF) SIGNAL INDICATORS (Red) --- These AF indicators are used to indicate the audio input signals being received from the transmitters.

5. INFRARED SIGNAL SYNC BUTTONS --- There are two infrared signal SYNC buttons, one for Channel A and one for Channel B. Keep both transmitters' power on. Press the Channel A Sync button and then align the INFRARED SIGNAL RECEIVING WINDOW (refer to numeral 20 on page 9 for handheld transmitter and numeral 26 on page 10 for body pack transmitter) to the IR Window (refer to numeral 6 below) of the AWR6525U receiver, the above transmitter will be synchronized to the Channel A frequency and the Channel A RF LED light (green) will be turned on to indicate that the above transmitter's signal has been received by the receiver. Press the Channel B Sync button and then align the INFRARED SIGNAL RECEIVING WINDOW to the IR Window of the AWR6525U receiver, the above transmitter will be synchronized to the Channel B frequency and the Channel B RF LED light (green) will be turned on to indicate that the above transmitter's signal has been received by the receiver.

6. INFRARED SIGNAL EMISSION WINDOW (IR WINDOW)

7. POWER LED INDICATOR (Red)

REAR PANEL

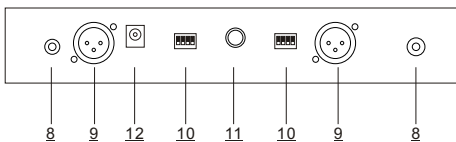

8. TNC ANTENNA JACKS

9. BALANCED MICROPHONE OUTPUTS (XLRM Jacks)

10. 16-FREQUENCY DIP SWITCHES There are two sets of 16-frequency DIP switches, one for Channel A and the other for Channel B. The sixteen (16) adjustable frequencies can be adjusted by setting the DIP switches. The frequencies corresponding to the DIP switch settings are listed as follows: (NOTE: **0 = DIP Switch down; 1 = dip Switch up**)

DIP Switches 4321	Channel Number	Channel A Frequencies (MHz)	Channel B Frequencies (Mhz)
0000	0	663.050	688.700
0001	1	670.650	679.400
0010	2	663.300	677.500
0011	3	666.050	682.750
0100	4	667.100	678.450
0101	5	667.850	678.700
0110	6	669.350	680.950
0111	7	662.500	681.500
1000	8	663.150	675.550
1001	9	668.050	682.250
1010	10	664.300	677.350
1011	11	666.950	681.950
1100	12	664.550	678.450
1101	13	662.350	679.050
1110	14	660.200	684.000
1111	15	661.800	678.950

11. UNBALANCED MICROPHONE OUTPUT (1/4" Jack) --- This is a mixed unbalanced microphone output from both Channel A and Channel B (mixed output).

12. 12 DC INPUT (Tip Positive) Allowable Voltage Range: 12-15VDC.

HANDHELD WIRELESS MICROPHONE

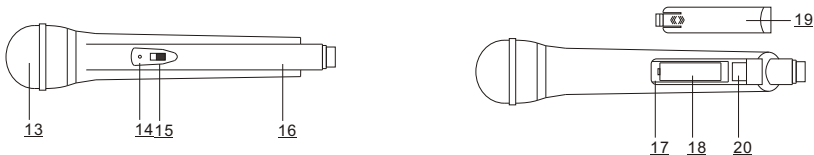

13. MICROPHONE WINDSCREEN

14. POWER ON/OFF LED INDICATOR

15. POWER ON/OFF SWITCH

16. HANDHELD MICROPHONE BODY

17. BATTERY COMPARTMENT

18. BATTERIES --- 2 X AA alkaline batteries or 2 X NiMH rechargeable AA batteries

19. MICROPHONE BATTERY COVER

20. INFRARED SIGNAL RECEIVING WINDOW --- This IR window is hidden under the microphone battery cover (numeral 19). In order to synchronize the frequency of the handheld microphone to the frequency of the AWR6525U receiver, the microphone battery cover needs to be opened and set aside to expose this IR window. Place this window 4 inches (10cm) away and facing the receiver IR window to proceed to the transmitter frequency synchronization.

BODY-PACK WIRELESS TRANSMITTER

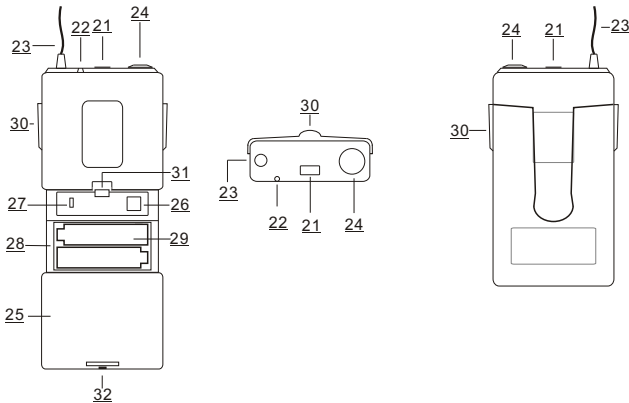

21. POWER ON/OFF & MUTE BUTTON --- This button is to be used as a power On/Off switch and as a mute button. When the body-pack transmitter power is off, press this button steadily to turn on the power and the green Power LED Indicator will be turned on. While the power is on, press this button steadily to turn off the power and the green Power LED Indicator will be turned off. If the power is on and this button is pressed once, this button will have the body-pack transmitter muted and the power LED indicator will turn yellow. If the body-pack transmitter is muted, press this button once again to turn off the mute and the power LED indicator will turn back to green. If the power level of the AA batteries is low, the power LED indicator will start to blink between green and yellow.

22. POWER LED (Green) /MUTE LED (Yellow) INDICATOR

23. ANTENNA

24. MICROPHONE INPUT

25. BATTERY COMPARTMENT COVER

26. INFRARED SIGNAL RECEIVING WINDOW --- This IR window is hidden under the body-pack transmitter battery cover (numeral 25). In order to synchronize the frequency of the body-pack transmitter to the frequency of the AWR6525U receiver, the body-pack transmitter battery cover needs to be flipped open to expose this IR window. Place this window 4 inches (10cm) away and facing the receiver IR window to proceed to the transmitter frequency synchronization.

27. AUDIO INPUT ATTENUATION SWITCH (0dB & -10dB) --- This switch needs to be set to the 0dB position when the lavalier microphone is used. This switch needs to be set to the -10dB position when the headset microphone is used.

28. BATTERY COMPARTMENT

29. BATTERIES --- 2 X AA alkaline batteries or 2 X NiMH rechargeable AA batteries

30. BELT CLIP

31. BATTERY COMPARTMENT COVER LATCH

32. LATCH BUTTON

OPERATION NOTES

1. The AWX6525U, AWX6525UG, AWX6525UH, and AWX6525UM need to be turned off before changing the AA batteries.
2. Signal dropout or unexpected noise may be caused by a low battery or by an excessive distance between the transmitter and the receiver. If you encounter signal dropout or unexpected noise, please check the batteries first. If the batteries are still fresh, try to readjust the antennas on the AWR6525U receiver.
3. Avoid placing the receiver in a corner to prevent any RF reception deterioration.
4. Avoid placing the receiver antennas close to an obstruction or close to any metal surface.
5. Try to place the receiver as far away from the digital equipment, including computers and CD players, as possible.

6. If more than one AWR6525U wireless microphone receivers are stacked together or placed in a rack, do not let the antennas touch each other or cross each other.
7. Before the AWR6525U is to be used in a new location, place the AWR6525U receiver at the intended location and walk through the area with the transmitters to locate any radio frequency blind spots, where a momentary loss of sound or short period of noise may occur whenever the transmitters are moved to these spots.
8. Do not drop the transmitter on the floor or strike the transmitter with any object.
9. Always turn off the transmitter and remove the batteries if the transmitter is not to be used for a period of time to prevent the transmitter from being damaged by leaking batteries.

SPECIFICATIONS

AWR6525U RECEIVER

RECEIVING MODE	SUPERHETERODYNE DOUBLE CONVERSION
INTERMEDIATE FREQUENCIES	110MHz, 10.7MHz
ANTENNA INPUT	TNC / 50 Ω
SENSITIVITY	15dBuV
SENSITIVITY REGULATING RANGE	15-30dBuV
RF SQUELCH	>80dB
WEIGHT	1.0 lbs (0.45 Kg)
DIMENSIONS (W X D X H)	9.6" X 6.9" X 1.7" (245 X 175 X 44 mm)

AWX6525U TRANSMITTER

ANTENNA	BUILT-IN ANTENNA, QUARTER-WAVE WHIP ANTENNA
EMISSION POWER	8mW
MAX SPL	130dB
IMAGE SPURIOUS	>70dB
MICROPHONE CARTRIDGE	HANDHELD MICROPHONE: DYNAMIC LAVALIER or HEADSET: ELECTRET CONDENSER
BATTERIES	ALKALINE AA X 2 or RECHARGEABLE AA X 2

AWM6525U SYSTEM

FREQUENCY RANGE	UHF
MODULATION MODE	FM
OSCILLATION MODE	VCO + PLL
DEVIATION	±45KHz (COMPRESS-EXPAND and AUTOMATIC-VOLUME- LIMIT CIRCUIT)
CHANNEL WIDTH	30MHz
S/N RATIO	>85dB
TOTAL HARMONIC DISTORTION	<0.3% (1 KHz, A WEIGHTING)
FREQUENCY RESPONSE	80 - 15,000 Hz (±3dB)

TROUBLESHOOTING

Should problems occur, they are, in many cases, due to simple operation mistakes or the like. On the basis of the following checks, you will be able to rectify a number of problems yourself without difficulty. If the problem cannot be remedied after the following checks, please consult your dealer.

PROBLEM	POSSIBLE CAUSES	SOLUTIONS
No sound and no RF signal	The power of the transmitter is off.	Turn on the transmitter.
	Incorrect AA-battery polarity in the transmitter.	Correct the AA-battery polarity.
	Antenna is not on the receiver or bad antenna connection.	Install the antenna or check the antenna connection.
	Transmitter too far away from the antenna or RF signal blocked.	Reposition the transmitter to closer area or remove the RF signal block.
No sound while RF and AF signals normal.	Receiver volume turned to minimum.	Adjust the volume control knob to have an optimal volume output.
	Receiver audio cable is missing or defective.	Connect, repair or replace the audio cables.
	Volume control of the sound system connected to the AWR6525U receiver is set to minimum.	Adjust the volume control on the sound system which is connected to the AWR6525U receiver.

No sound while RF signal is normal and AF signal does not exist.	The microphone cartridge of the transmitter is defective.	Return transmitter to factory or authorized service station for service.
Loud noise from receiver only when the transmitter is off.	Interference signal at that frequency.	Reposition receiver or adjust the antenna orientation. Select another operating frequency.
	Receiver is placed too close to an interference source, such as a computer, digital device, or CD player.	Move the receiver to another location. Select another operating frequency.
Loud noise from receiver even when the transmitter is on.	Another transmitter is using the same frequency.	Turn off another transmitter or change to a channel with a different frequency.
	Interference signal at that frequency.	Select another operating frequency.
	Receiver is placed too close to an interference source, such as a computer, digital device, or CD player.	Move the receiver to another location. Select another operating frequency.
Distorted sound	Low transmitter battery level.	Replace transmitter battery.
	The volume control on the receiver is set too high, overloading the subsequent sound device input.	Turn down the volume control on the AWR6525U receiver.
Short range or signal dropouts.	Low transmitter battery level.	Replace transmitter battery.
	Poor antenna reception.	Reposition antenna or receiver.
	Interference Signal.	Select another operating frequency.
	Too many obstacles between the receiver and transmitter.	Move the obstacles or move the receiver away from nearby metal objects.
Momentary loss of sound when transmitter is moved around the performing area.	Radio frequency (RF) blind spots.	Reposition the receiver. If the momentary loss of sound problem cannot be removed, walk through the performing area and mark "Blind" spots. Avoid these "Blind" spots during performance.

SERVICE INFORMATION

SHIPPING DAMAGE

If the shipping carton is found to be damaged, notify the delivery company immediately. Save the damaged carton as evidence for the delivery company to inspect. It is the responsibility of the consignee to file a claim with the delivery company for any damage that occurs during shipping. In the case that the shipping carton is in good condition but the unit is damaged or defective, call **Audio2000'S®** at 805/523-2759.

FACTORY SERVICE

If the equipment needs factory service, call **Audio2000'S®** at 805/523-2759 for a Return Authorization number (RA number) and the address of the authorized service representatives. Insure and ship the product, prepaid, in its original carton along with proof of purchase in the form of a bill of sale or receipted invoice to the above address. Please clearly write the RA number on the shipping carton. Also enclose a note describing the problem along with any other helpful information such as where and how the unit was used.

LIMITED WARRANTY

H&F Technologies, Incorporated (H&F) hereby warrants that **Audio2000'S®** products will be free from defects in material and workmanship for a period of 1 (one) year from date of purchase. At its option, H&F will repair or replace the defective product and promptly return it to you.

The Limited Warranty will not cover any item that has been, in H&F's estimation, subject to alteration, misuse, neglect, accident or improper installation. In addition, any service not performed by H&F or an authorized service center will terminate terms of this warranty. Normal wear and tear of this product will not be covered by this or any implied warranty.

No liability will be accepted for damages/loss directly caused from the use of this product. H&F's liability shall be limited to the repair/replacement of this product if found to be defective.

© 2013 H & F Technologies, Incorporated (website: www.audio2000s.com)